

0 611 205 603; 703

Issue } 03-10-14 **Fig./Abb. 2**
Stand }

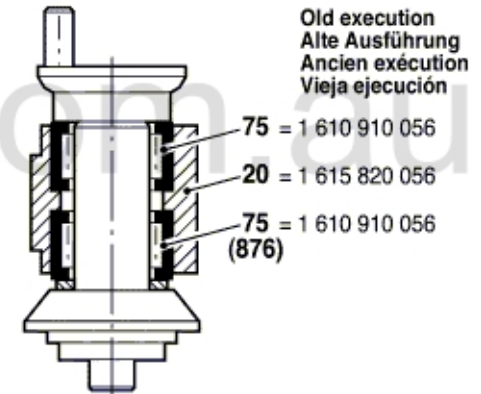
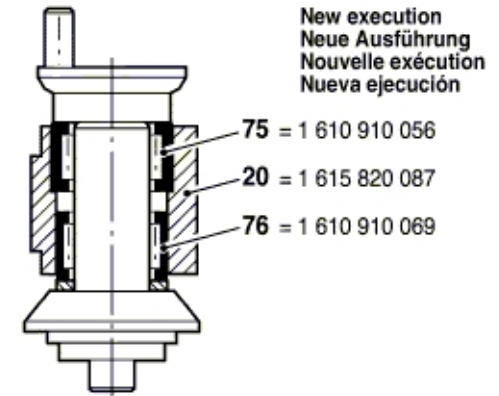
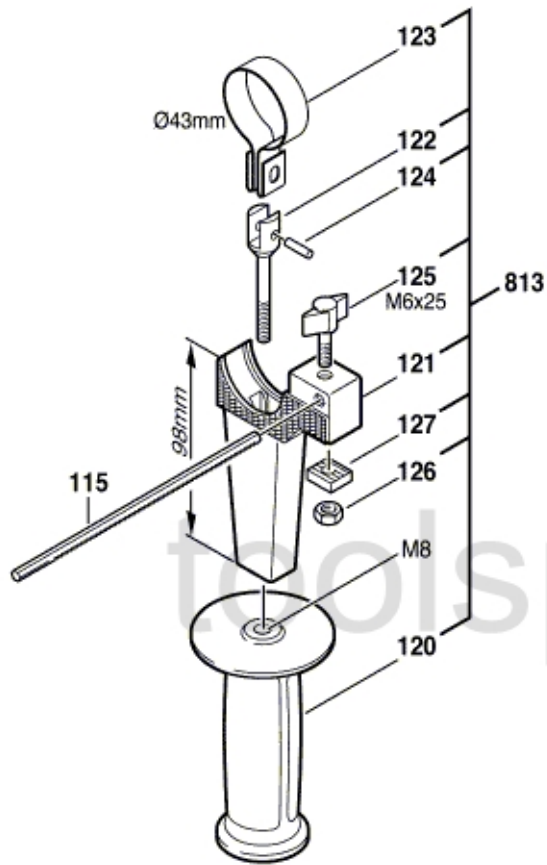

Modifications reserved
Änderungen vorbehalten
Modifications réservées
Salvo modificaciones